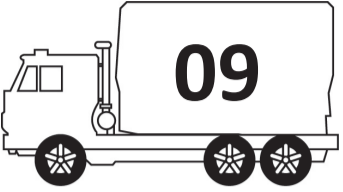
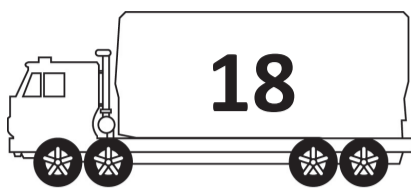
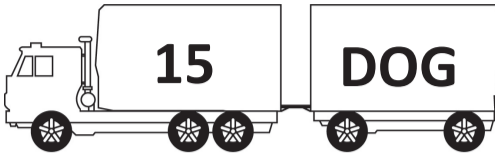
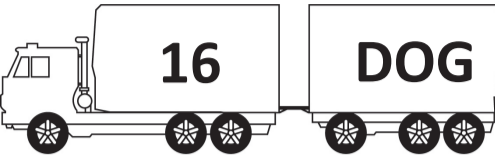
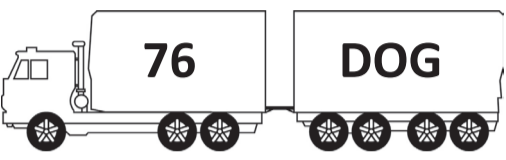

GRAINS HARVEST MANAGEMENT SCHEME TABLE OF COMMON GROSS SCHEME LIMITS

Vehicles are provided a GHMS mass flexibility but must not exceed Manufacturer's Ratings.

RIGID TRUCK

 <p>09</p> <p>GML: 22.5 CML: 23.25 HML: 23.00 GHMS: 24.20</p>	 <p>18</p> <p>GML: 27.50 CML: 28.50 HML: No GHMS: 29.60</p>	 <p>15 DOG</p> <p>GML: 40.50 CML: 41.50 HML: No GHMS: 43.50</p>	 <p>16 DOG</p> <p>GML: 42.50 CML: 43.50 HML: No GHMS: 45.70 Extra: Under guideline up to 45.5</p>
---	---	---	---

 <p>76 DOG</p> <p>GML: 42.50 CML: 43.30 HML: No PBS: Yes GHMS: 45.70 Extra: Under guideline up to 50.00</p>
--

PRIME MOVER AND SEMI TRAILER

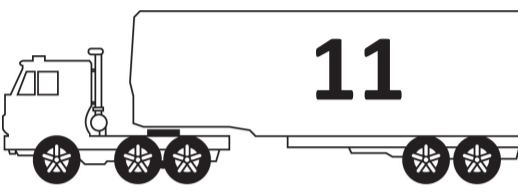
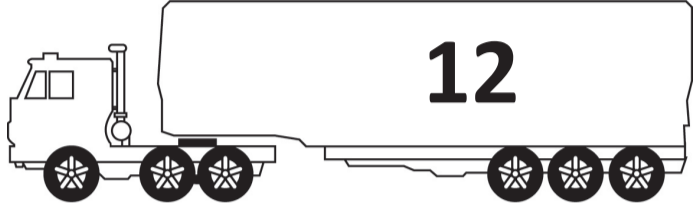
 <p>11</p> <p>GML: 39.00 CML: 40.00 HML: No GHMS: 41.90</p>	 <p>12</p> <p>GML: 42.50 CML: 43.50 HML: 45.50 GHMS: 45.70</p>
--	--

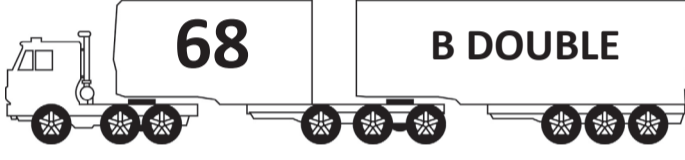
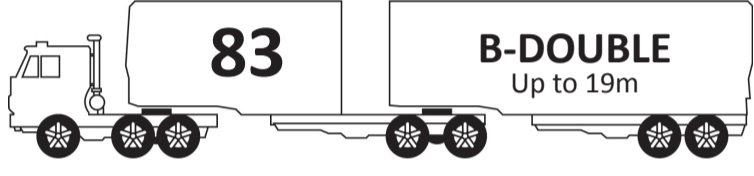

B-DOUBLE

 <p>68 B DOUBLE</p> <p>GML: 62.50 CML: 64.50 HML: 68.00 GHMS: 67.10</p>	 <p>83 B-DOUBLE Up to 19m</p> <p>Running on B-Double Route GML: 55.50 CML: 57.00 HML: 57.00 GHMS: 59.70</p> <p>General Access GML: 50.0 CML: 51.00 HML: 57.00 GHMS: 53.70</p>
---	---

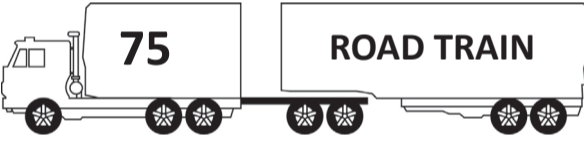
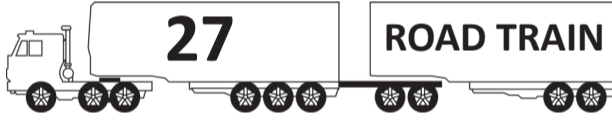
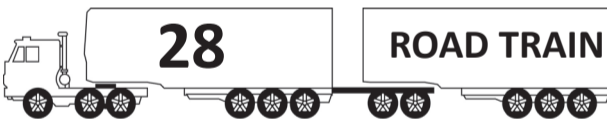
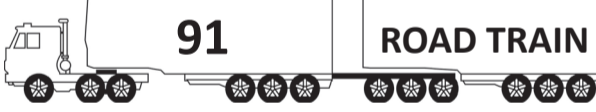
ROAD TRAIN (Type 1: up to 36.50m)

 <p>75 ROAD TRAIN</p> <p>GML: 55.50 CML: 57.25 HML: 57.00 GHMS: 59.60</p>	 <p>27 ROAD TRAIN</p> <p>GML: 75.50 CML: 77.50 HML: 79.50 GHMS: 81.10</p>
 <p>28 ROAD TRAIN</p> <p>GML: 79.00 CML: 81.00 HML: 85.00 GHMS: 84.90</p>	 <p>91 ROAD TRAIN</p> <p>GML: 82.50 CML: 84.50 HML: 90.50 GHMS: 88.70</p>

ROAD TRAIN (Type 2: up to 53.50m)

 <p>74 ROAD TRAIN</p> <p>GML: 115.50 CML: 118.50 HML: 124.50 GHMS: 124.10</p>
 <p>89 ROAD TRAIN</p> <p>GML: 122.50 CML: 126.50 HML: 135.50 GHMS: 131.70</p>
 <p>90 ROAD TRAIN</p> <p>GML: 119.00 CML: 122.00 HML: 130.00 GHMS: 128.00</p>

AB TRIPLE

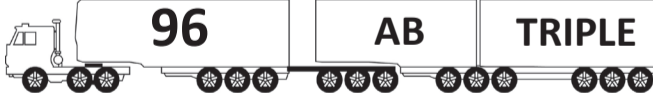
 <p>88 AB TRIPLE</p> <p>GML: 99.00 CML: 102.00 HML: 107.50 GHMS: 106.40</p>	 <p>96 AB TRIPLE</p> <p>GML: 102.50 CML: 105.50 HML: 113.00 GHMS: 110.10</p>
--	---

The GHMS weights listed above are the maximum allowed under the scheme - there are no additional concessions or allowances under GHMS.

ABBREVIATIONS:

GML: General Mass Limit - Otherwise known as Standard or Regulation Mass Limit

CML: Concessional Mass Limit - Must be registered under NHVAS with the NHVAS sticker visible

HML: Higher Mass Limit - Must be registered under NHVAS +IAP + on a HML approved route

GHMS: Grain Harvest Management Scheme - Stickers on truck must be sighted and recorded

Extra: Additional allowance if running under a Notice, permit or guideline.

NOTES:

Performance Based Standards (PBS) vehicles operate under a permit or notice and are governed by those permit or notice weights. PBS vehicles do not operate under GHMS.



Queensland
Government

